

A PROPHECY OF A MESSIAH

Old Testament Lesson #128

In Isaiah 8, great judgments were to fall upon Israel and Aram (A-ram) (Syria). The people were to be taken captive by the Assyrians (a-SIR-i-anz) and have their wealth stolen. Even Judah was threatened by the “floodwaters ... reaching up to the neck.” (Assyria came right up to Jerusalem but was turned back.)

Chapter 9 speaks of hope. There will be no more gloom, and the people who had been humbled will be honored. Light will replace darkness. People will rejoice as they do when the harvest is finished, or when they are dividing plunder. They will feel free from oppression as they did at Midian’s (MID-i-an) defeat (see Judges 7:20-21).

This light and rejoicing will be a result of the promised child.

- He is to be a son who will bear the responsibility of ruling the people.
- He will be called, “Wonderful Counselor, Mighty God, Everlasting Father, Prince of Peace.”
- “Of the increase of his government and peace there will be no end.”
- He will reign with justice and righteousness from David’s throne, establishing it forever. This will come to pass because the LORD has determined to accomplish it.

POINTS TO CONSIDER:

- Matthew quotes Isaiah 9:2 in Matthew 4:15-16.

A Prophecy of a Messiah

- I. Israel and Aram will be judged.
 - A. People will be captured by the Assyrians.
 - B. Their money will be stolen.
- II. Life will be better when the promised child is born.
 - A. There will be hope and light.
 - B. People will rejoice.
 - C. Righteousness and justice will return forever.
 - D. God will accomplish the changes.

ANSWER KEY:

Wonderful Counselor, Mighty God, Everlasting Father, Prince of Peace

Isaiah said that light and rejoicing will come in a promised child!

He will be called



_____ ,
 A B C R D F G H I J B H C K D I B F

_____ ,
 L M N O P Q N B R

_____ ,
 D S D F I T K P M C N G T P O D F

_____ ,
 W F M C J D B G W D T J D

Follow these instructions ...

change the I's to L
 change the B's to O
 change the K's to S
 change the F's to R
 change the M's to I
 change the C's to N
 change the P's to T
 change the J's to C
 change the N's to G
 change the D's to E

change the L's to M
 change the W's to P
 change the G's to F
 change the Q's to Y
 change the R's to D
 change the A's to W
 change the T's to A
 change the S's to V
 change the O's to H
 change the H's to U

Name _____

A promised child would bring light.

Circle all the things that give light.

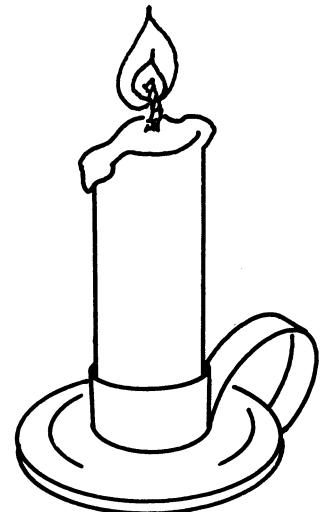
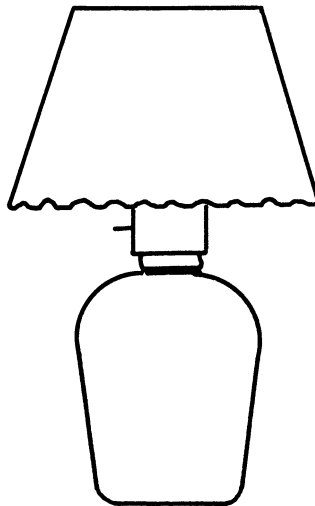
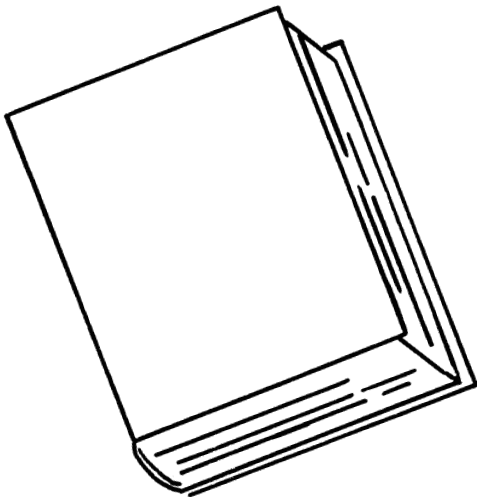
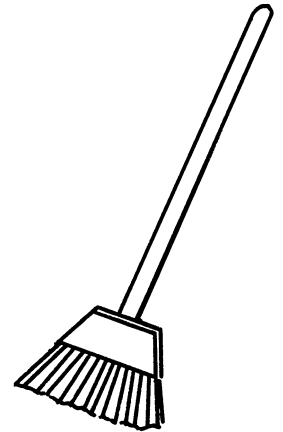
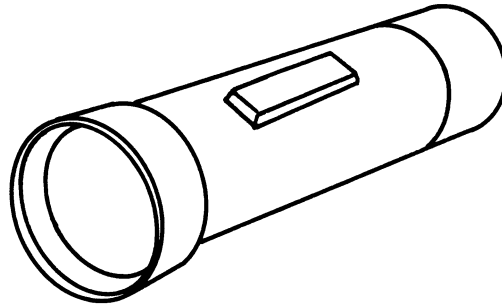
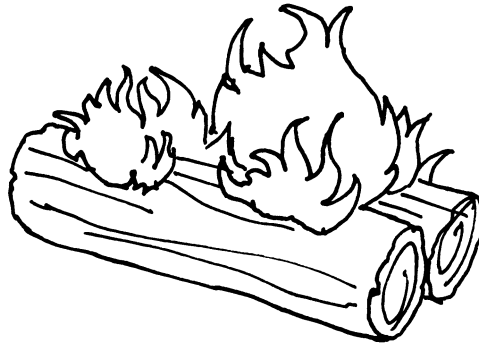
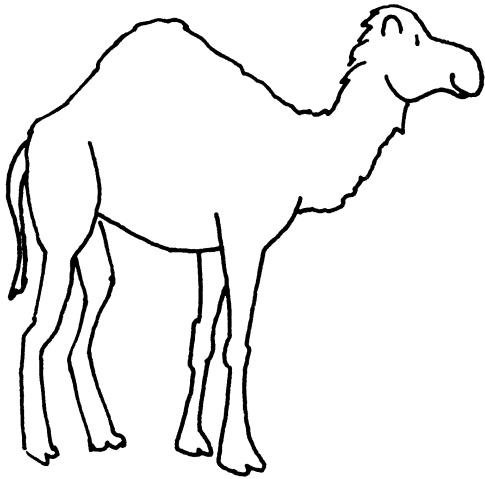
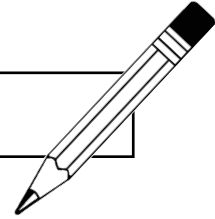

Name _____